









33 805 875



- saillie 166 mm
- bec pivotant 360°
- jet laminaire
- hauteur de robinetterie 303 mm
- hauteur jusqu'au mousseur: 186 mm
- diamètre de percement 35 mm
- débit d'eau maxi. 8 l/min avec une pression d'écoulement de 3 bars
- sans plomb
- Ce produit contribue au respect des exigences des systèmes d'évaluation des bâtiments écologiques, par exemple LEED®, BREEAM®, DGNB

	Noir mat	33 805 875-33
	Chrome	33 805 875-00
	Platine brossé	33 805 875-06
	Platine	33 805 875-08
	Laiton (Or 23cts)	33 805 875-09
	Dark Chrome	33 805 875-19
	Laiton brossé (Or 23cts)	33 805 875-28
	Champagne brossé (Or 22cts)	33 805 875-46
	Champagne (Or 22cts)	33 805 875-47
	Chrome brossé	33 805 875-93
	Dark Platinum brossé	33 805 875-99

Accessoires recommandés

**Distributeur sans rosace - Noir mat** 82 424 970-33



Accessoires recommandés

**Commande de vidage individuelle manuelle Commande manuelle - Noir mat** 10 712 970-33



33 805 875

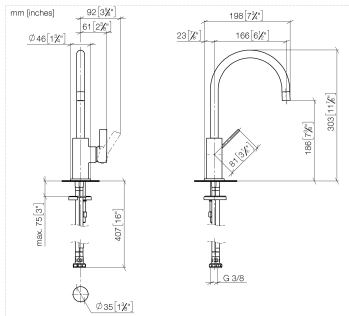

### Diagramme de débit

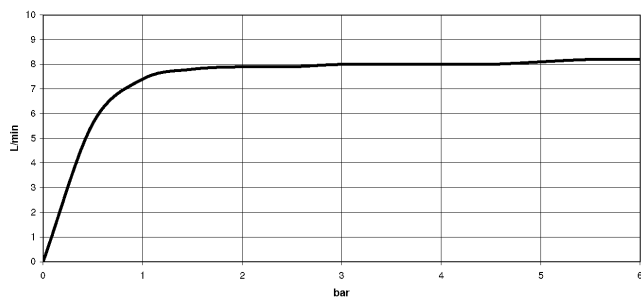

### Certificats

LGA\_18899.

33 805 875

Les pièces pour les autres finitions peuvent être trouvées ici : [Chrome](#)

